

Fit tips!

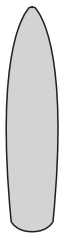

x2

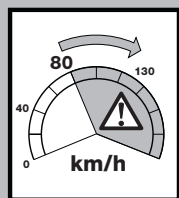
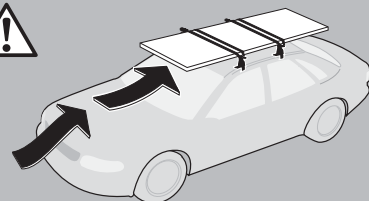
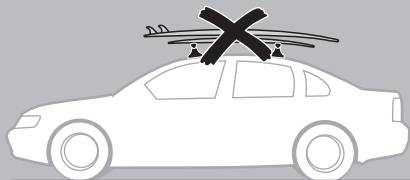
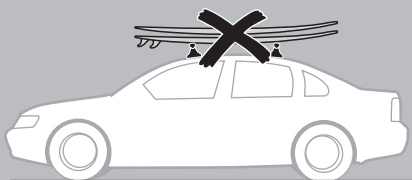
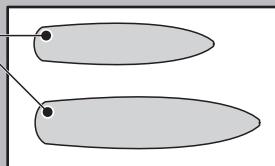
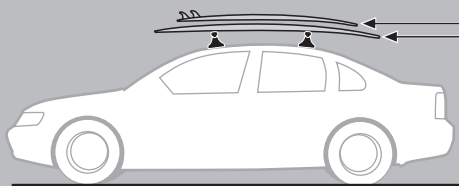
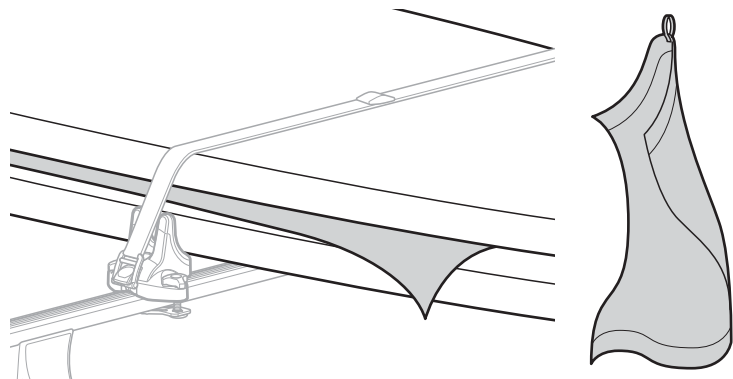

THULE[®]

SWEDEN

Box 69, 330 33 Hillerstorp, SWEDEN
www.thule.com

542 4DF/501-7008-02

THULE[®]

SWEDEN

- S** Monteringsanvisning
- GB** Fitting instructions
- D** Montageanleitung
- F** Instructions de montage
- NL** Montage-instructies
- FIN** Asennusohje
- E** Instrucciones de montaje
- I** Istruzioni per il montaggio
- CZ** Návod na montáž
- PL** Instrukcja montażu
- HU** Szerelési utasítások
- RU** Инструкции по установке
- EST** Paigalduseeskirjad
- SLO** Navodila za pritrjevanje

한국어 장착 지침

日本語 取扱(取付)説明書

中文 安装说明

Se n^o houver instruções no seu idioma, entre em contato com os funcionários/Érios do estabelecimento para obter informações.

Eğer talimatlar dilinizde basılı değilse, lütfen atölye personelinin bilgi isteyiniz.

Αν οι οδηγίες δεν εκτυπώνονται στη γλώσσα σας, παρακαλούμε ζητήστε πληροφορίες από το προσωπικό του καταστήματος.

ถ้าไม่มีคำแนะนำในภาษาของคุณ

โปรดติดต่อพนักงานในร้านเพื่อขอข้อมูล

832

1000-68



Follow me...

